



LED Clamps

Specifications and Instruction Guide

MBS-Standoffs.com

SKU	LWR100A-180A	LBR100A-180A	LRR100A-180A
-----	--------------	--------------	--------------

- Package Includes**
- ▶ 1 x LED Clamp
 - ▶ 1 x Splitter (Supports up to 2 LED Clamps)
 - ▶ 1 x Low voltage transformer adapter
 - ▶ 2 x Screws and Anchors
 - ▶ 1 x Allen Key
 - ▶ Instruction Guide

Clamp

Length	7-1/16" (180mm)	Distance From Wall	1" (25.4mm)
Material Thickness Accepted	Between (0 to 5/16")	Material	Clear Anodized
Anchor for Concrete	ANC2	Anchor for Drywall	ANC6, ANC6Z

LED

Power	1W	Lumen	68-76
Data	<ul style="list-style-type: none"> ▶ Input Voltage: 100-240VAC 50HZ ▶ Output Voltage: DC12V ▶ Working current: 16mA ▶ Color rendering index: RA70 	<ul style="list-style-type: none"> ▶ Droop coefficient: 5000H±10% ▶ Operating ambient temperature: 0-45C ▶ Ambient humidity: Max 90% RH 	

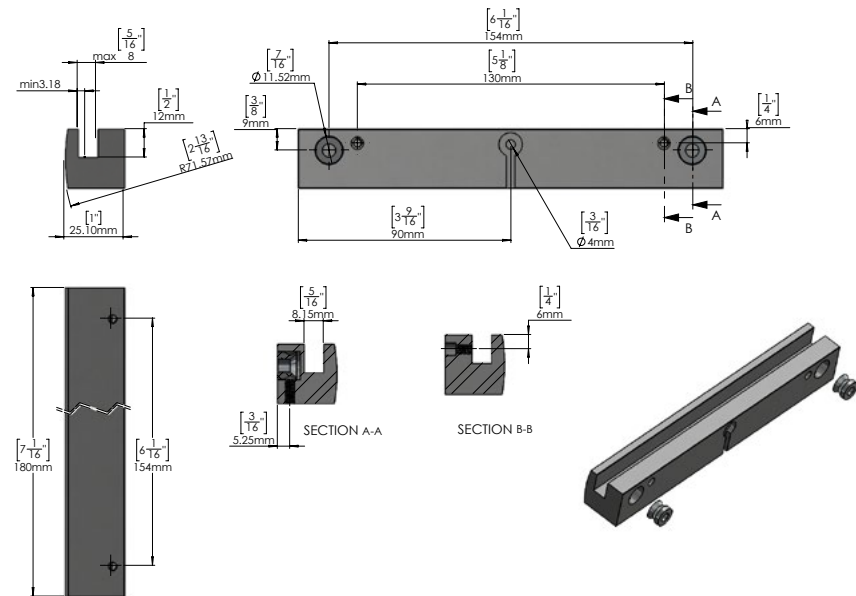

This document and the product mentioned in Reference are the exclusive property of MBS-Standoffs, they can not be used, reproduced, disclosed or disclosed without prior authorization

Drill Template



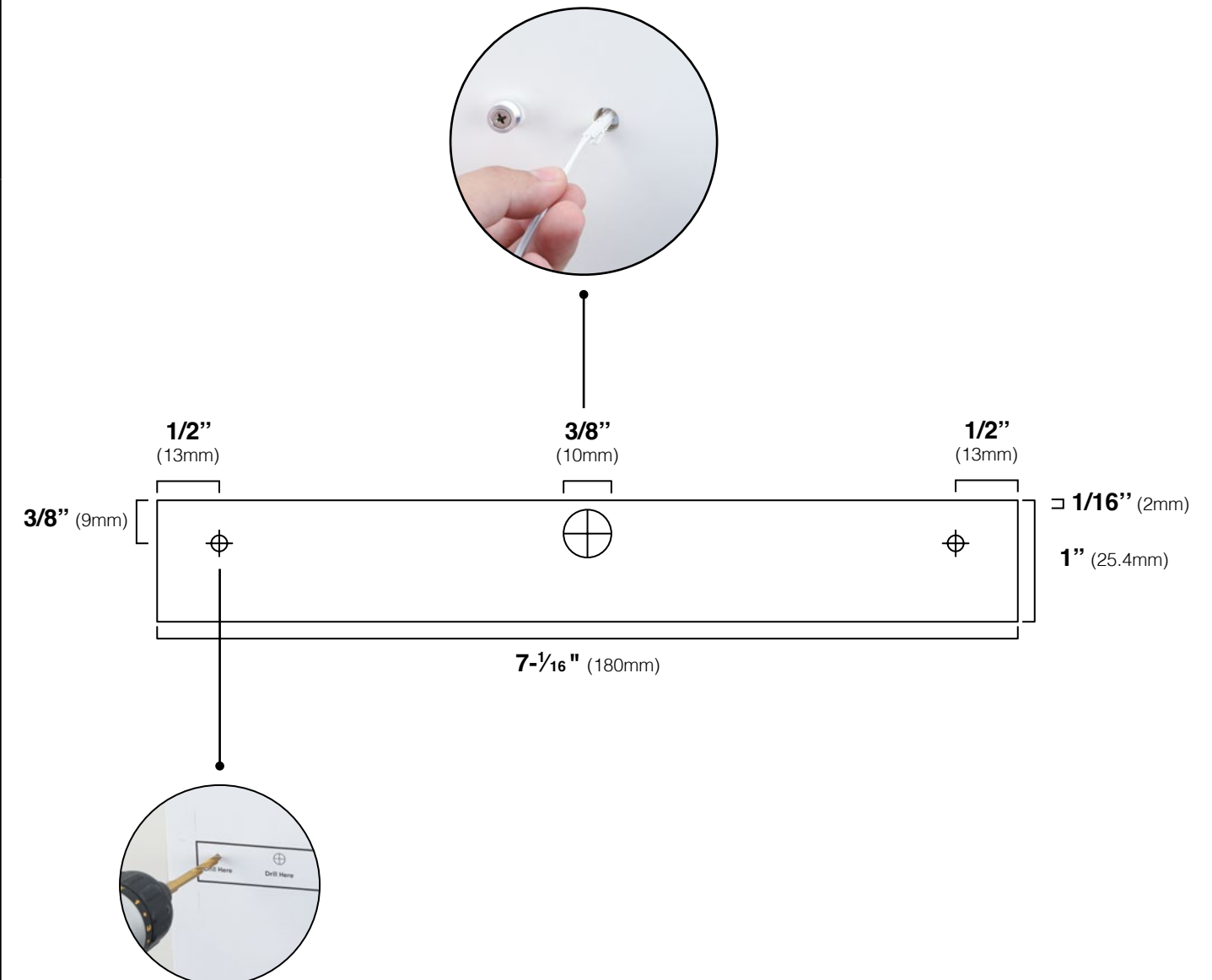

Mark your drill locations according to drawing measurements.

⚠ Installation must be performed by a certified electrician.



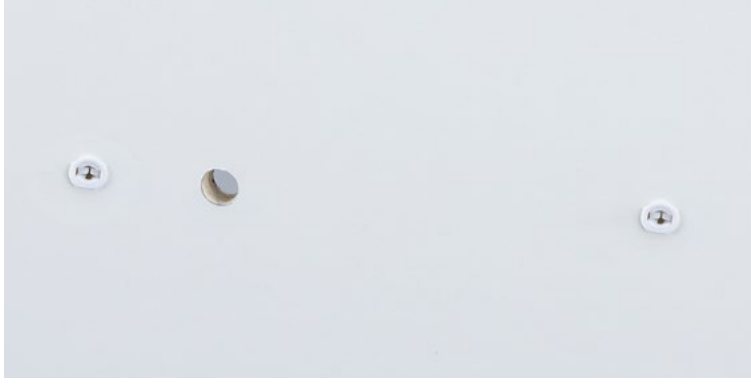

Installation Steps

⚠ Installation must be performed by a certified electrician.

Directions	
1	Place template on wall with tape. Make sure that template is level. 
2	Drill holes into the wall where marks were located. 
3	Insert supplied anchors into the wall. 
4	Mount the barrels to the wall. 

Installation Steps

⚠ Installation must be performed by a certified electrician.

Directions	
5	Thread the cable through the wall opening. <i>(Sign must be mounted on LED Clamp before this step)</i> 
6	Position two barrels into the sockets. 
7	Utilize an allen wrench to tighten the clamps securely onto the wall. 

This document and the product mentioned in reference are the exclusive property of MBS-Standoffs, they can not be used, reproduced, disclosed or disclosed without prior authorization!